



DOĞSAN

ÜRÜN KATALOĐU



Cerrahi Dikiş Malzemeleri



Cerrahi Dikiş Malzemeleri



● Sürekli Gelişme/İlerleme

Doğsan'ın temel hedefi sürekli gelişme ile müşteri memnuniyetini arttırmaktır.

● Takım Çalışması

Doğsan deneyimli ve yetenekli personeli ile takım çalışmasına inanarak hedeflerini gerçekleştireceğinin bilindedir.

güvenilir çözüm ortağınız

● Deneyimli

Bölgesindeki ilk suture üreticisi olan Doğsan, 1970 yılında kurulmuştur ve suture üretiminde köklü bir geçmişe sahiptir. Doğsan, kalitesiyle Türkiye hastanelerinde saygı duyulan bir markadır ve kaliteli ürünlerini global pazara sunmaktadır.

● Her ihtiyacı karşılamaya yönelik sutureler

Doğsan, emilebilir ve emilmeyen sutureleri ile geniş kapsamlı bir ürün yelpazesine sahiptir. Doğsan USP 12/0 - USP 8 aralığındaki sutureleri ile kardiyovasküler cerrahi, mikrocerrahi ve göz cerrahisini de içeren tüm cerrahi branşların ihtiyaçlarını karşılayacak ürünler sunmaktadır.

● Müşteri Odaklılık

Doğsan, cerrahların, hemşirelerin ve bayilerin ihtiyaçlarını karşılamanın sorumluluğunun bilincindedir.

Modern cerrahi değişimlerinin gereği olarak, Doğsan deneyimi ve müşteri odaklılığı ile teknolojisini ve ürün yelpazesini cerrahların ve hemşirelerin ihtiyaçlarına göre uyumlulaştırır.

● Kalite Yönetimi

Doğsan'da kalite prensipleri; üretim, pazarlama, satış ve yönetim süreçlerinin her kademesinde ciddiyetle uygulanır.

● Global Standartlar

ISO 13485 Kalite Yönetim Sistem (ISO 9001)

93/42/EEC Tıbbi Cihazlar Direktifi ()

EP (Avrupa Farmakopesi)

USP (Amerika Birleşik Devletleri Farmakopesi)

cGMP (İyi İmalat Kuralları)

Ürün İndeksi

emilebilir



emilmeyen



mikrocerrahi
ve oftalmoloji

Katalog bilgilerinin açıklaması

İğne açıklaması: iğne tipi ve özellikleri	İğne şekli ve ucu	İğne çapı	Sütür rengi	Sütür uzunluğu (cm)	Ürün tablosu - Ürünler USP (alt) ve metrik (üst) ölçülerine göre listelenmiştir.		
					0.7	1	1.5
iğne bilgileri		iğne çapı	renk	iplik boyu	6/0	5/0	4/0
13 mm							
3/8 yuvarlak		330 μ	renksiz	45 cm	J131		
		330 μ	mor	45 cm	L131		
		330 μ	mor	60 cm		L231	
		430 μ	mor	60 cm			L331
3/8 PL		380 μ	mor	45 cm	L139		
		430 μ	mor	45 cm		L239	
iğne uzunluğu (mm)		Ürün kodu					

Etiket Bilgileri

Ürün Etiketi

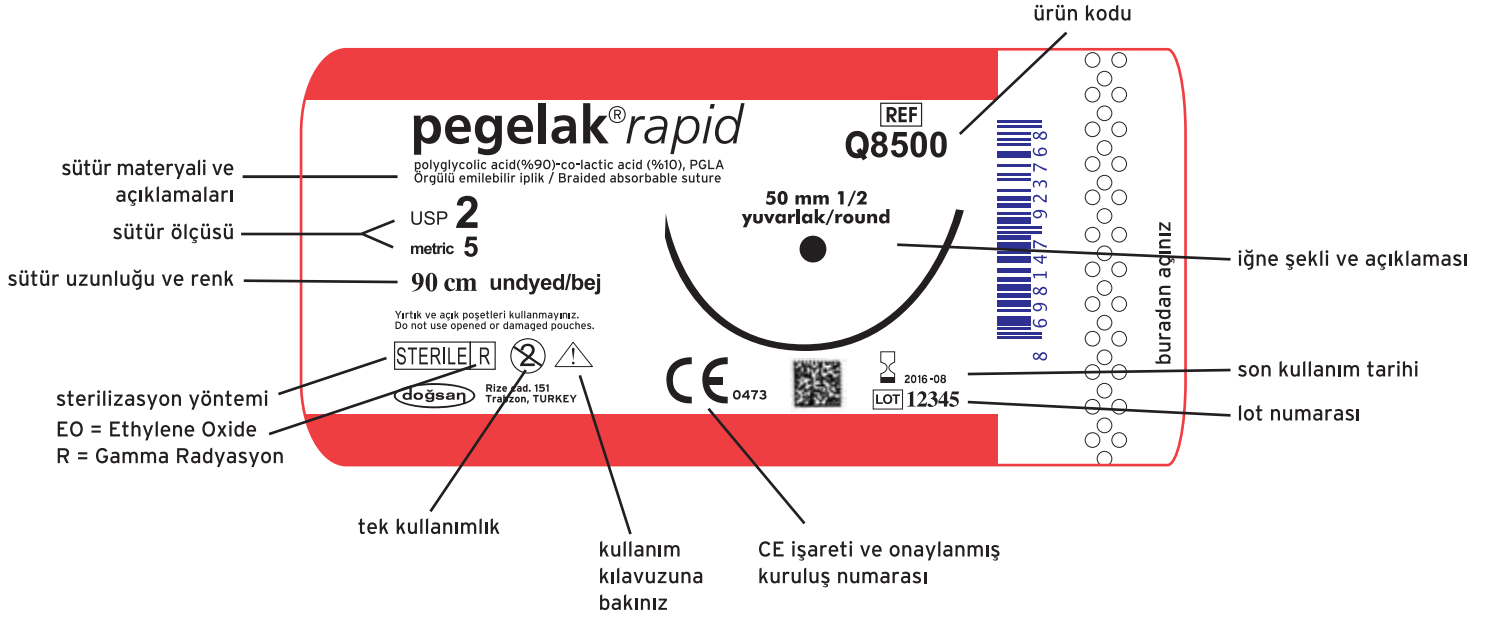

Dış Kutu (12'lik) Etiketi



EP/USP Mukavemet Tablosu (minimum deęerler)

USP	metrik	EMİLMEYEN					SENTETİK EMİLEBİLİR			
		ÇAP (mm)	MUKAVEMET (kgf)		ÇELİK TEL MUKAVEMET (kgf)		ÇAP		MUKAVEMET (kgf)	
			min-max	min	ortalama	min	ortalama	MONOFILAMENT min-max (mm)	MULTIFILAMENT min-max (mm)	min
11/0	0.1	0.010 - 0.019	-	0.003			-	-	-	
10/0	0.2	0.020 - 0.029	-	0.010			-	-	-	
9/0	0.3	0.030 - 0.039	0.006	0.035			-	-	0.023	0.045
8/0	0.4	0.040 - 0.049	0.015	0.060			-	0.040 - 0.049	0.035	0.070
7/0	0.5	0.050 - 0.069	0.030	0.102			0.050 - 0.094	0.050 - 0.069	0.070	0.140
6/0	0.7	0.070 - 0.099	0.060	0.150			0.095 - 0.149	0.070 - 0.099	0.130	0.250
5/0	1	0.100 - 0.149	0.102	0.310			0.150 - 0.199	0.100 - 0.149	0.340	0.680
4/0	1.5	0.150 - 0.199	0.150	0.510			0.200 - 0.249	0.150 - 0.199	0.470	0.950
3/0	2	0.200 - 0.249	0.310	0.920			0.250 - 0.339	0.200 - 0.249	0.890	1.750
2/0	3	0.300 - 0.349	0.920	1.530			0.340 - 0.399	0.300 - 0.349	1.340	2.680
0	3.5	0.350 - 0.399	1.330	2.240			0.400 - 0.499	0.350 - 0.399	1.850	3.900
1	4	0.400 - 0.499	1.530	2.750			0.500 - 0.570	0.400 - 0.499	2.540	5.080
2	5	0.500 - 0.599	2.240	3.570	4.420	5.900	0.571 - 0.610	0.500 - 0.599	3.180	6.350
3 & 4	6	0.600 - 0.699	2.750	5.100	6.830	9.110	-	-	-	-
5	7	0.700 - 0.799	3.570	6.320	8.550	11.400	-	-	-	-
6	8	0.800 - 0.899	5.100	7.450	10.200	13.600	-	-	-	-
7	9	0.900 - 0.999	-	-	11.930	15.980	-	-	-	-
8	10	1.000 - 1.099	-	-	13.650	18.200	-	-	-	-

EP ve USP'den uyarlanan bu tablodaki mukavemet deęerleri basit dđđüm ile asgari çekme kuvvetleridir.



İğnelerimiz



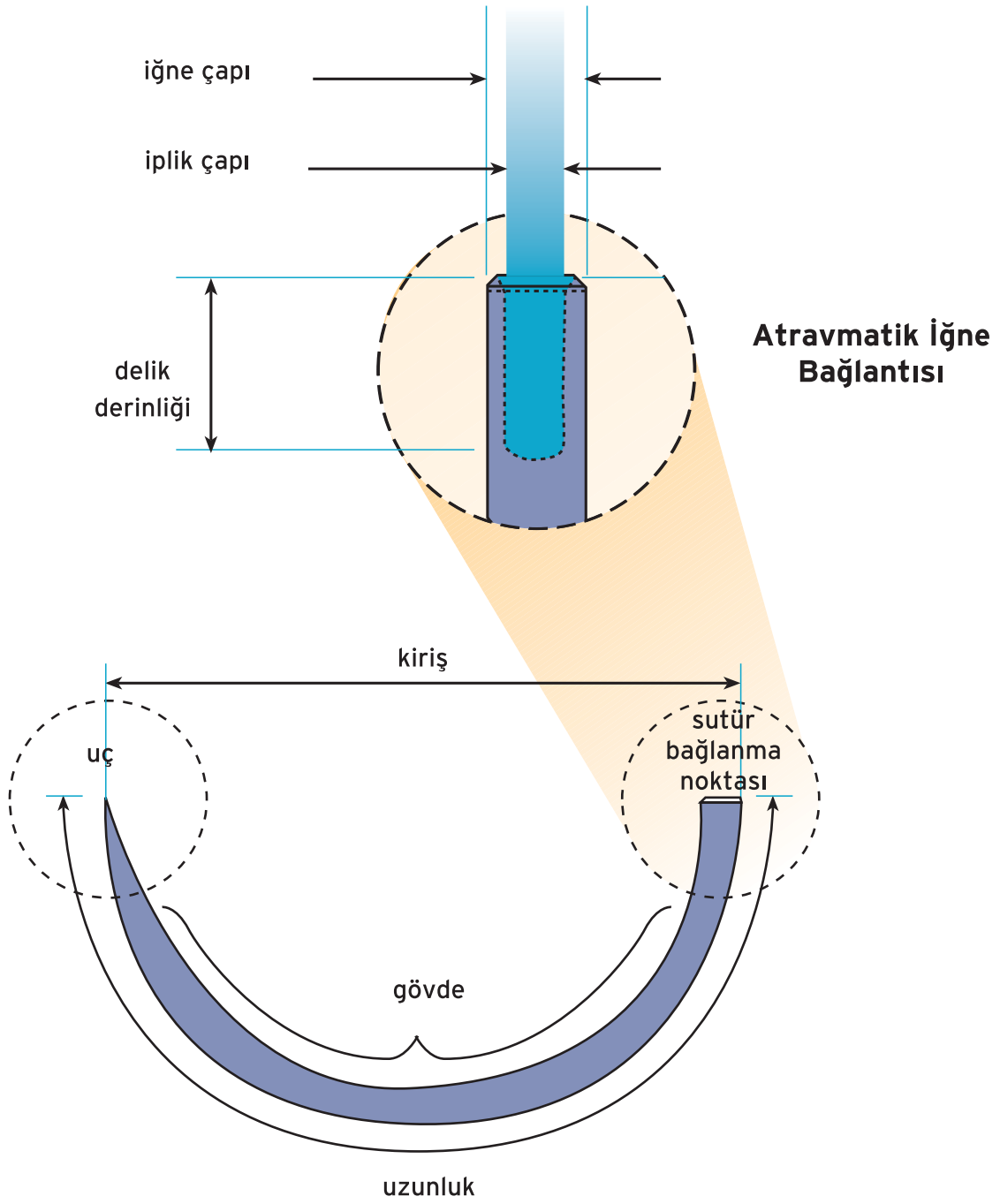







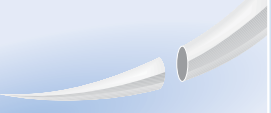

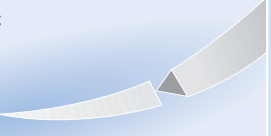





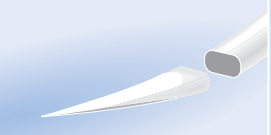

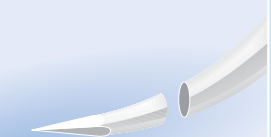

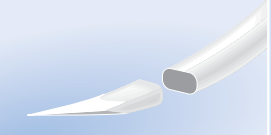
Atravmatik İğnelerin Yapısı

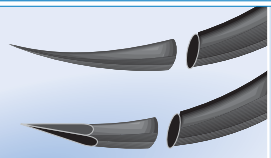

Şekillerine Göre İğneler

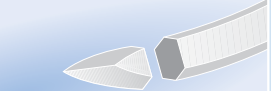

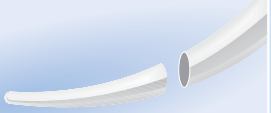
Atravmatik Cerrahi İğnelerimiz

isim	uç	gövde	sembol	açıklama
yuvarlak				<ul style="list-style-type: none">• En yaygın kullanılan klasik iğne türüdür.• Kalp damar cerrahisi dahil olmak üzere tüm yumuşak doku kapatmalarında kullanılır.
keskin	iç 			<ul style="list-style-type: none">• Kolay ve yumuşak penetrasyon için kenarları özel bilenmiş iğne türüdür.• İç kısmı kesicidir.• Cilt kapatmalarında ve kesici iğne gerektiren tüm uygulamalarda kullanılır.
	dış 			<ul style="list-style-type: none">• Kolay ve yumuşak penetrasyon için kenarları özel bilenmiş iğne türüdür.• Dış kısmı kesicidir.• Cilt kapatmalarında, özellikle plastik cerrahide kullanımı yaygındır.
PL				<ul style="list-style-type: none">• Kolay penetrasyon ve yüksek bükülme direnci için, ince gövde yapılı özel geometriye sahiptir.• Plastik ve kozmetik cerrahi ve cilt kapatmalarında kullanımı yaygındır.
KD				<ul style="list-style-type: none">• Kalp damar cerrahisi, kireçlenmiş damarlar ve fibroze olmuş dokular için özel olarak üretilmiştir.• Gövde kısmı kare şekline getirilerek bükülmeye karşı direnci artırılmıştır.• Uç kısmı sivrileştirilerek penetrasyon özelliği artırılmıştır.
diamond (taper cut)				<ul style="list-style-type: none">• Daha iyi penetrasyon ve daha az doku travmasına neden olacak şekilde yuvarlak iğnenin ucu keskin hale getirilmiştir.• Özellikle kalp damar ve göğüs cerrahisinde, ortopedide ve kadın doğum cerrahisinde kullanılır. Ayrıca tendonlarda ve fibroze olmuş dokularda da kullanılır.
siyah		 	 	<ul style="list-style-type: none">• Daha net görüşün ve iğnedeki parlamanın engellenmesinin istendiği durumlarda kullanılır. (ör: kan yoğunluğunun yüksek olması)• Metalin siyah rengi yüzey oksitleme tekniğiyle sağlanmıştır.• Özellikle kalp damar cerrahisi için kullanımı yaygındır.
spatül				<ul style="list-style-type: none">• Gövdesi yassı, yan kenarları ve üst yüzeyi kesicidir.• Özellikle oftalmik cerrahide kullanımı yaygındır.
küt				<ul style="list-style-type: none">• Yuvarlak iğnenin sivriliğinin azaltılmış türüdür.• Özellikle karaciğer tamiri olmak üzere hassas dokularda kullanılır.

Yuvarlak (taper) iğneler

3/8

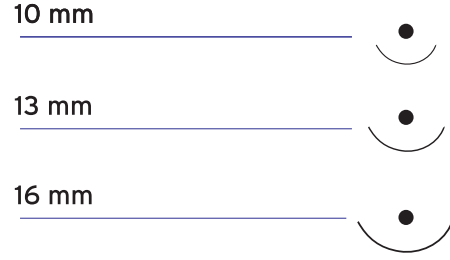
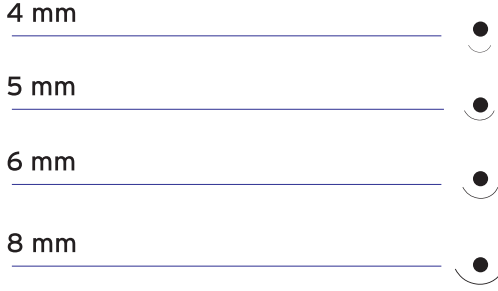

1/2

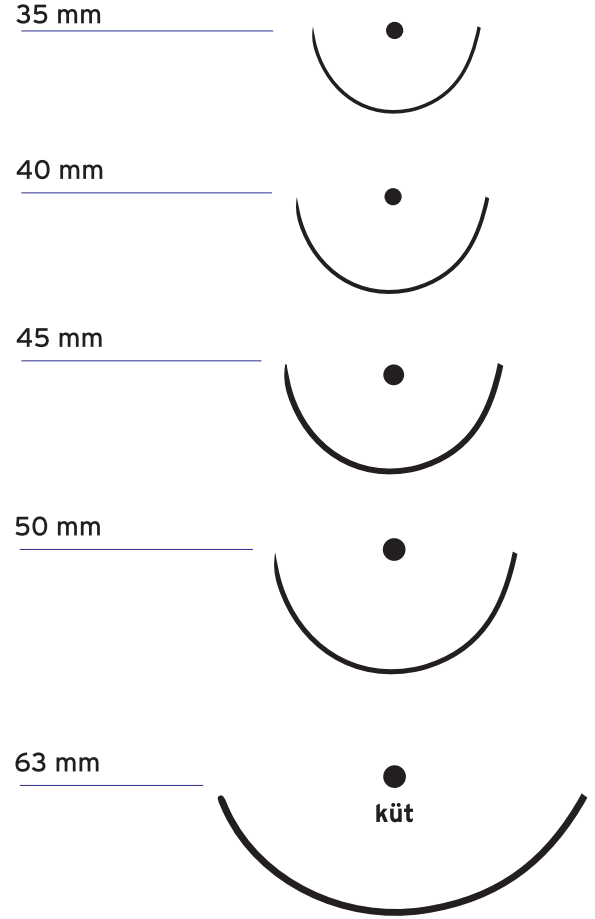
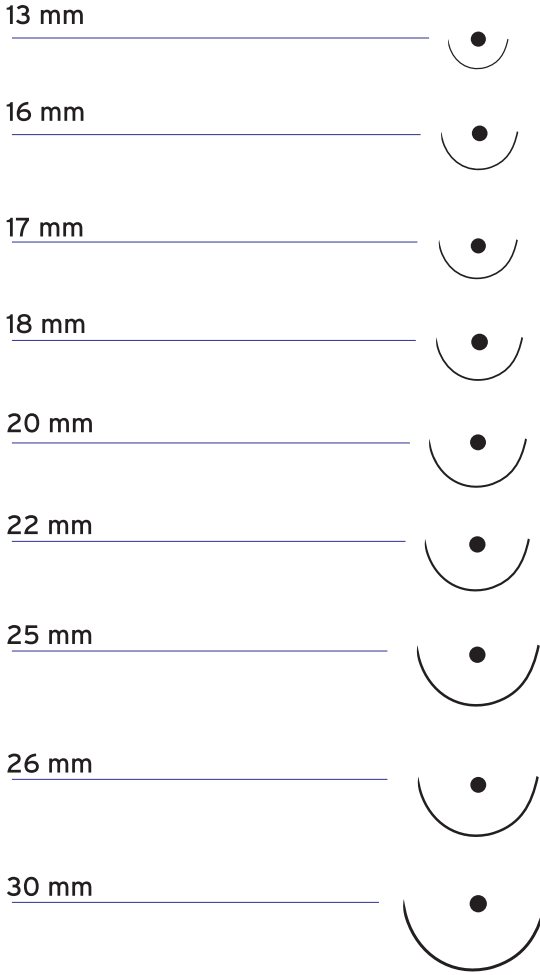

5/8



Keskin İğneler

1/2

22 mm



30 mm



37 mm



40 mm



50 mm



Düz

13 mm



18 mm



50 mm



60 mm



3/8

8 mm



10 mm



13 mm



16 mm



18 mm



20 mm



25 mm



26 mm



30 mm



35 mm



40 mm



50 mm



90 mm



Özel İğneler

Diamond
(taper cut)

KD

3/8

18 mm



1/2

17 mm



25 mm



40 mm



45 mm



55 mm



3/8

8 mm



10 mm



10 mm



13 mm



1/2

16 mm



20 mm



25 mm



Özel İğneler

Siyah

3/8

8 mm



10 mm



10 mm



13 mm



1/2

16 mm



20 mm



25 mm



Spatül İğneler

3/8

6 mm



1/4

8 mm



PL

13 mm



16 mm



19 mm



25 mm



Özel İğneler

Loop

40 mm

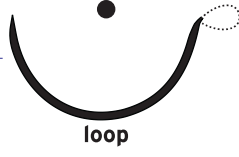

45 mm

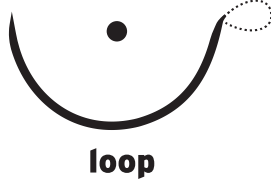

50 mm

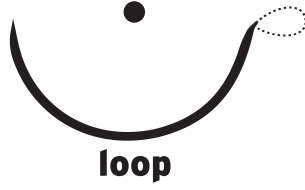



Emilebilir Sütürlerimiz

Emilebilir sütürler için doku destek grafiđi

Yaklaşık doku destek süreleri*

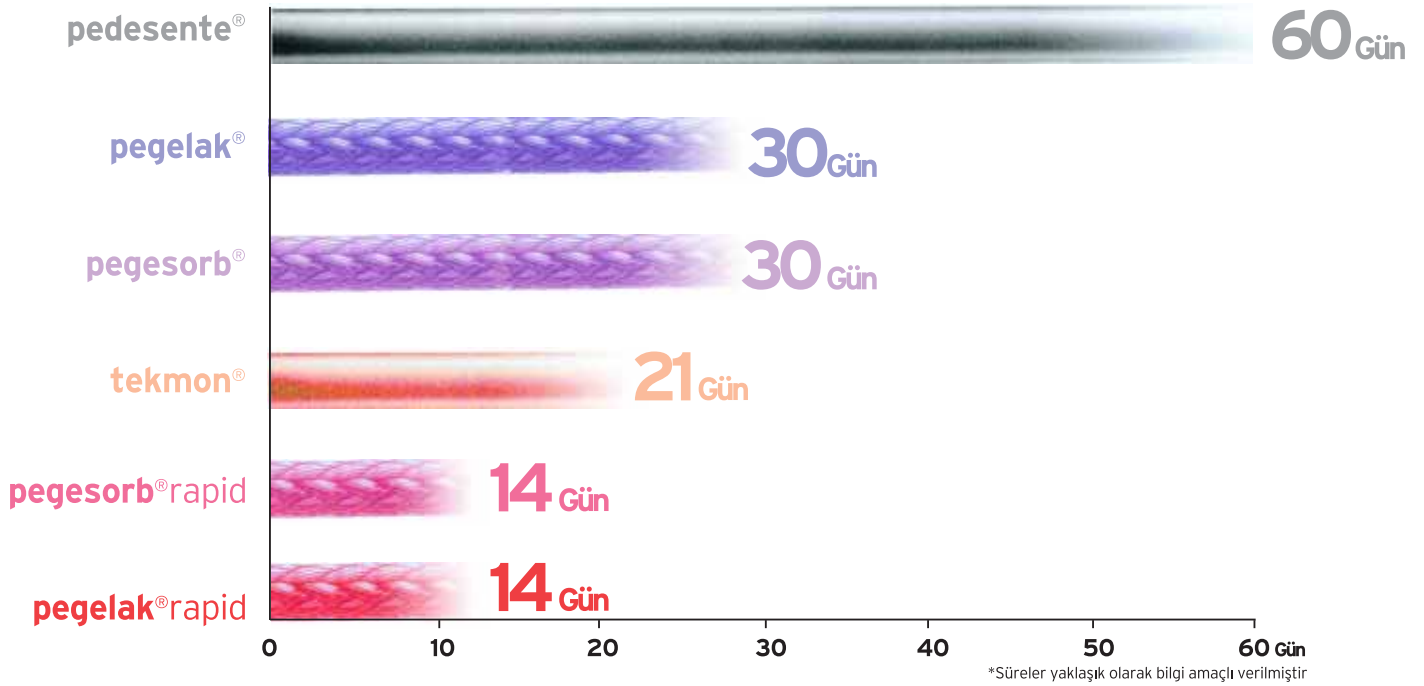

**Her ihtiyacınıza uygun
sentetik emilebilir sütürler**



pegelak®

USP **3/0** metric 2 REF **L4255**
pegelak

surgical suture/cerrahi iplik
örgüü/braided, absorbable (emilebilir)
coated/kaplanmış,
poly(glycolide-co-lactide) (PGLA)

violet/mor
45 cm

25 mm 3/8
keskin/cutting



CE 0473

LOT 12345

2011-10

2016-10







STERILE EO

dogsan



Form No: F-09/90 Rev. No: 0



Ürün Tanımı:	Kaplanmış, örgülü, orta dönem doku desteği için performansı ve polimer kompozisyonu kanıtlanmış sentetik emilebilir güvenilir cerrahi suture
Özellikleri:	Kullanımda mükemmel kolaylık Yüksek başlangıç mukavemeti Yüksek düğüm güvenliği ve kolay düğümleme ("tie-down") Orta dönem doku destek süresi (~ 30 gün)
Mukavemet:	Çok yüksek (USP standardlarının çok üzerinde) ~ % 75 2 hafta sonra ~ % 50 3 hafta sonra ~ % 0 4. -5. haftadan sonra
Emilim Profili:	Tamamen emilim süresi yaklaşık 56-70 gün
Polimer Yapısı :	polyglycolic acid (%90)-co-L-lactid acid (%10), PGLA (glycolide ve L-lactide (90:10) kopolimeri)
Kaplama Malzemesi:	poly(glycolide-co-L-lactide) & calcium stearate
Filament Yapısı:	Örgülü (multifilament)
Renk:	Mor/ renksiz (bej)
Sterilizasyon Yöntemi:	EO (Etilen Oksit)
USP Aralığı & Ambalaj:	USP 7/0 (metric 0,5) - USP 2 (metric 5) aralığında; suture neme karşı koruyan alüminyum folyo poşetlerde 12'lik (düzinelik) kutularda piyasaya arz edilir.

iğne bilgileri	iğne çapı	renk	iplik boyu	0.5	0.7	1	1.5	
				7/0	6/0	5/0	4/0	
8 mm								
1/4 spatül, çift		280µ	mor	45 cm		L1882		
		330µ	mor	45 cm			L2882	
10 mm								
1/2 keskin		280µ	mor	45 cm	L0042			
3/8 keskin		330µ	mor	45 cm		L103		
13 mm								
3/8 yuvarlak		330µ	renksiz	45 cm		J131		
		330µ	mor	45 cm		L131		
		330µ	mor	60 cm			L231	
		330µ	renksiz	60 cm			J231	
		380µ	mor	60 cm				L331
3/8 PL		330µ	mor	45 cm		L139	L239	
düz diamond		430µ	mor	75 cm			L338	



iğne bilgileri	renk	iplik boyu	1	1.5	2	3	3.5
			5/0	4/0	3/0	2/0	0











16 mm							
1/2 yuvarlak		mor	75 cm	L2160	L3160	L4160	
3/8 keskin		mor	75 cm	L2165	L3165	L4165	
		renksiz	75 cm	J2165			
3/8 PL		mor	45 cm	L2169	L3169		
		renksiz	75 cm	J2169			

18 mm							
1/2 yuvarlak		mor	75 cm		L3180	L4180	
düz diamond		mor	75 cm		L3188		

19 mm							
3/8 PL		mor	45 cm	L2199	L3199	L4199	
		renksiz	45 cm	J2199	J3199	J4199	

20 mm							
1/2 yuvarlak		mor	75 cm		L3200	L4200	
3/8 keskin		mor	45 cm		L3203	L4203	
		mor	75 cm		L3213		

25 mm							
1/2 yuvarlak		mor	75 cm		L3250	L4250	L5250
		mor	90 cm			L4260	L5240
3/8 keskin		mor	45 cm		L3255	L4255	L5255
3/8 PL		mor	45 cm		L3259	L4259	

iğne bilgileri	renk	iplik boyu	2	3	3.5	4	5	
			3/0	2/0	0	1	2	
26 mm								
3/8 keskin		mor	75 cm	L4263	L5263			
		renksiz	75 cm	J4263	J5263			
30 mm								
1/2 yuvarlak		mor	75 cm	L4300	L5300	L6300	L7300	
		mor	90 cm		L5310	L6310	L7310	
3/8 keskin		mor	75 cm	L4303	L5303	L6303		
		renksiz	75 cm	J4303	J5303	J6303		
35 mm								
1/2 yuvarlak		mor	75 cm		L5350	L6350	L7350	
		mor	90 cm				L7360	
3/8 keskin		mor	75 cm	L4353	L5353			
1/2 diamond		mor	90 cm		L5356	L6356		
36 mm								
5/8 yuvarlak		mor	75 cm			L6368		
40 mm								
1/2 yuvarlak		mor	75 cm		L5400	L6400	L7400	L8400
		mor	90 cm			L6410	L7410	
1/2 keskin		mor	90 cm			L6414	L7414	
1/2 diamond		mor	90 cm			L6406	L7406	

iğne bilgileri	renk	iplik boyu	1.5	2	3	3.5	4	5
			4/0	3/0	2/0	0	1	2

45 mm									
1/2 yuvarlak		mor	75 cm					L7450	L8450
		mor	90 cm					L7460	

50 mm									
1/2 yuvarlak		mor	75 cm			L5500	L6500	L7500	L8500
		mor	90 cm				L6510	L7510	L8510

60 mm									
düz keskin		mor	75 cm	L3608	L4608				
		renksiz	75 cm	J3608					

63 mm									
3/8 küt karaciğer iğnesi	 küt	mor	75 cm					L7638	
		mor	100 cm					L7658	

	renk	1	1.5	2	3	3.5	4
		5/0	4/0	3/0	2/0	0	1

iğnesiz								
150 cm	mor	L25	L35	L45	L55	L65	L75	
6x45 cm	mor	L22	L32	L42	L52	L62	L72	
12x45 cm	mor		L34	L44	L54	L64		



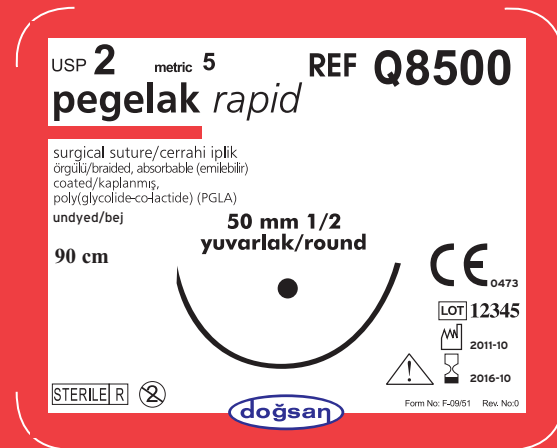

pegelak[®]rapid







Ürün Tanımı:	Kaplanmış, örgülü, kısa dönem doku desteği sağlayan sentetik emilebilir sütürdür. Hızlı iyileşen yaralar için idealdir.
Özellikleri:	Hızlı emilim - hasta konforunun artışı, başarılı kozmetik sonuçlar Mükemmel kullanım kolaylığı Yüksek düğüm güvenliği ve kolay düğümleme ("tie-down") Kısa dönem doku desteği (~ 14 gün)
Mukavemet:	~ %50 5.gün ~ %0 14.gün
Emilim Profili:	Tamamen emilim süresi yaklaşık 42 gün
Polimer Yapısı:	polyglycolic acid (%90)-co-L-lactid acid (%10), PGLA (glycolide ve L-lactide (90:10) kopolimeri)
Kaplama Malzemesi:	poly(glycolide-co-L-lactide) & calcium stearate
Filament Yapısı:	Örgülü (multifilament)
Renk :	Renksiz (bej)
Sterilizasyon Yöntemi:	Gamma Işınlama
USP Aralığı & Ambalaj:	USP 6/0 (metric 0.7) - USP 2 (metric 5) aralığında; sütürü neme karşı koruyan alüminyum folyo poşetlerde 12'lik (düzinelik) kutularda piyasaya arz edilir.



iğne bilgileri	renk	iplik boyu	0.7	1	1.5	2
			6/0	5/0	4/0	3/0

13 mm						
3/8 keskin		renksiz	45 cm	Q133		
3/8 PL		renksiz	45 cm	Q139	Q239	
düz diamond		renksiz	75 cm			Q338

16 mm							
1/2 yuvarlak		renksiz	45 cm	Q1160			
		renksiz	75 cm		Q2160	Q3160	Q4160
3/8 keskin		renksiz	75 cm		Q2165	Q3165	Q4165
3/8 PL		renksiz	75 cm		Q2169	Q3169	



18 mm							
1/2 yuvarlak		renksiz	75 cm			Q3180	Q4180

19 mm							
3/8 PL		renksiz	45 cm			Q3199	Q4199

20 mm							
1/2 yuvarlak		renksiz	75 cm			Q3200	Q4200
3/8 keskin		renksiz	75 cm			Q3213	Q4213



22 mm							
1/2 yuvarlak		renksiz	45 cm			Q3220	Q4220

iğne bilgileri	renk	iplik boyu	1.5	2	3	3.5	4
			4/0	3/0	2/0	0	1



25 mm							
1/2 yuvarlak		renksiz	75 cm	Q3250	Q4250	Q5250	
3/8 keskin		renksiz	45 cm		Q4255	Q5255	
3/8 PL		renksiz	45 cm	Q3259	Q4259		



26 mm							
3/8 keskin		renksiz	75 cm		Q4263	Q5263	

30 mm							
1/2 yuvarlak		renksiz	75 cm		Q4300	Q5300	Q6300 Q7300

35 mm							
1/2 yuvarlak		renksiz	75 cm			Q5350	Q6350 Q7350
		renksiz	90 cm				Q6360
3/8 keskin		renksiz	75 cm		Q4353	Q5353	
1/2 diamond		renksiz	90 cm			Q5356	Q6356

iğne bilgileri	renk	iplik boyu	3	3.5	4	5
			2/0	0	1	2

40 mm							
1/2 yuvarlak		renksiz	75 cm	Q5400	Q6400	Q7400	Q8400
		renksiz	90 cm	Q5410	Q6410	Q7410	
1/2 diamond		renksiz	90 cm		Q6406	Q7406	

45 mm							
1/2 diamond		renksiz	90 cm		Q6456		
1/2 yuvarlak		renksiz	75 cm			Q7450	Q8450
		renksiz	90 cm		Q6450		

50 mm							
1/2 yuvarlak		renksiz	90 cm	Q5500	Q6500	Q7500	Q8500

	renk	1.5	2	3	3.5	4	5
		4/0	3/0	2/0	0	1	2

iğnesiz							
150 cm	renksiz	Q35	Q45	Q55	Q65	Q75	Q85
6x45 cm	renksiz	Q32	Q42	Q52			



pegesorb®

USP 1 metric 4 REF G7400
pegesorb

surgical suture/cerrahi iplik
örgülü/braided, absorbable (emilebilir)
coated/kaplanmış,
polyglycolic acid (PGA)
EP, USP
violet/mor

40 mm 1/2
yuvarlak/round

75 cm



CE 0473

LOT 12345

2011-10

2016-10

STERILE

dogsan

Form No: F-09/46 Rev. No:1



Ürün Tanımı:	Kaplanmış örgülü yapısı ve çok yüksek mukavemeti ile orta dönem doku desteği için en kullanışlı sentetik emilebilir cerrahi sütür.
Özellikleri:	Çok yüksek başlangıç mukavemet Yüksek kullanım kolaylığı (kolay düğüm atma) Yüksek düğüm güvenliği ve kolay düğümleme ("tie-down") Orta dönem doku destek süresi (~ 30 gün)
Mukavemet:	Çok yüksek (USP standartlarının çok üzerinde) ~ % 70 2 hafta sonra ~ % 50 3 hafta sonra ~ % 0 4. -5. haftadan sonra
Emilim Profili:	Tamamen emilim süresi yaklaşık 60-90 gün
Polimer Yapısı:	polyglycolic acid, PGA %100
Kaplama Malzemesi:	poly(glycolide-co-L-lactide) & calcium stearate
Filament Yapısı:	Örgülü (multifilament)
Renk:	Mor/ renksiz (bej)
Sterilizasyon Yöntemi:	EO (Etilen Oksit)
USP Aralığı & Ambalaj:	USP 8/0 (metric 0,4) - USP 2 (metric 5) aralığında; sütürü neme karşı koruyan alüminyum folyo poşetlerde 12'lik (düzinelik) kutularda piyasaya arz edilir.

iğne bilgileri	iğne çapı	renk	iplik boyu	0.4	0.5	0.7	1	1.5
				8/0	7/0	6/0	5/0	4/0



6 mm

3/8 spatül, çift		200µ	violet	45 cm	G9672				
------------------	---	------	--------	-------	-------	--	--	--	--



8 mm











1/4 spatül, çift		280µ	mor	45 cm		G0882	G1882		
		330µ	mor	45 cm				G2882	
3/8 keskin		220µ	mor	45 cm		G083			

10 mm

3/8 keskin		280µ	mor	45 cm			G103		
3/8 keskin, çift		280µ	mor	45 cm			G1032		

13 mm

3/8 yuvarlak		330µ	renksiz	45 cm			I131		
		330µ	mor	45 cm			G131		
		330µ	mor	60 cm				G231	
		380µ	mor	60 cm					G331
3/8 PL		330µ	mor	45 cm			G139	G239	



iğne bilgileri	renk	iplik boyu	1	1.5	2	3	
			5/0	4/0	3/0	2/0	
16 mm							
1/2 yuvarlak		mor	75 cm	G2160	G3160	G4160	
3/8 yuvarlak		mor	45 cm	G2161			
3/8 keskin		mor	75 cm	G2165	G3165	G4165	
3/8 PL		mor	45 cm	G2169	G3169		
18 mm							
1/2 yuvarlak		mor	75 cm		G3180	G4180	
19 mm							
3/8 PL		mor	45 cm	G2199	G3199	G4199	
20 mm							
1/2 yuvarlak		mor	75 cm		G3200	G4200	
3/8 keskin		mor	45 cm		G3203	G4203	
		mor	75 cm		G3213		
		mor	90 cm			G4213	
25 mm							
1/2 yuvarlak		mor	75 cm		G3250	G4250	G5250
		mor	90 cm			G4260	G5260
3/8 keskin		mor	45 cm		G3255	G4255	G5255
3/8 PL		mor	45 cm		G3259	G4259	



iğne bilgileri	renk	iplik boyu	2	3	3.5	4	5
			3/0	2/0	0	1	2

26 mm							
3/8 keskin		renksiz	75 cm	I4263	I5263		
		mor	75 cm	G4263	G5263		

27 mm							
5/8 yuvarlak		mor	75 cm		G5278		

30 mm							
1/2 yuvarlak		mor	75 cm	G4300	G5300	G6300	G7300
1/2 keskin		mor	75 cm		G5304	G6304	
3/8 keskin		mor	75 cm	G4303	G5303	G6303	

35 mm							
1/2 yuvarlak		mor	75 cm		G5350	G6350	G7350
		mor	90 cm		G5360		
3/8 keskin		mor	75 cm	G4353	G5353		
1/2 diamond		mor	90 cm		G5356	G6356	

40 mm								
1/2 yuvarlak		mor	75 cm		G5400	G6400	G7400	G8400
			90 cm			G6410	G7410	G8410
1/2 keskin		mor	90 cm			G6414	G7414	G8414
1/2 diamond		mor	90 cm			G6406	G7406	G8406

iğne bilgileri	renk	iplik boyu	3	3.5	4	5
			2/0	0	1	2

45 mm							
1/2 yuvarlak		mor	75 cm			G7450	G8450
			90 cm			G7460	

50 mm							
1/2 yuvarlak		mor	75 cm	G5500	G6500	G7500	G8500
		mor	90 cm		G6510	G7510	G8510

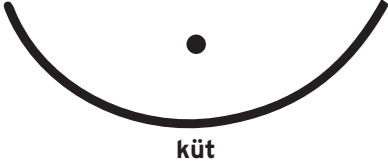
63 mm							
3/8 küt karaciğer iğnesi		mor	75 cm			G7638	

	renk	1	1.5	2	3	3.5	4
		5/0	4/0	3/0	2/0	0	1

iğnesiz							
150 cm	mor	G25	G35	G45	G55	G65	G75
6x45 cm	mor	G22	G32	G42	G52	G62	G72
12x45 cm	mor		G34	G44	G54	G64	



pegesorb® rapid

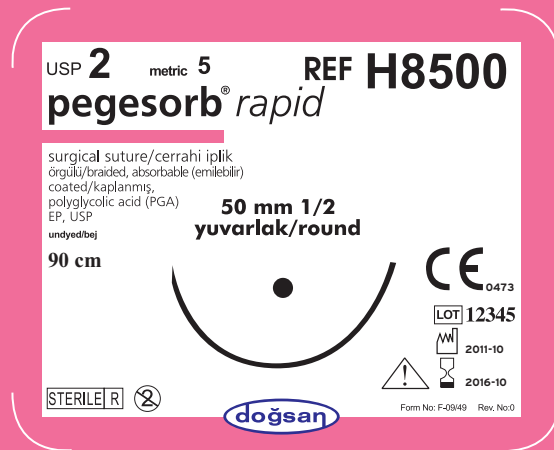





Ürün Tanımı:	Kaplanmış, örgülü, kısa dönem doku desteği sağlayan sentetik emilebilir sütürdür. Hızlı iyileşen yaralar için idealdir.
Özellikleri:	Hızlı emilim - hasta konforunun artışı, kozmetik sonuçlar Mükemmel kullanım Yüksek düğüm güvenliği kısa dönem doku desteği (~ 14 gün)
Mukavemet:	~ 50 % 5.gün ~ 0 % 14.gün
Emilim Profili:	Tamamen emilim süresi yaklaşık 42 gün
Polimer Yapısı:	polyglycolic acid, PGA 100%
Kaplama Malzemesi:	poly(glycolide-co-L-lactide) & calcium stearate
Filament Yapısı:	Örgülü (multifilament)
Renk :	Renksiz (bej)
Sterilizasyon Yöntemi:	Gamma ışınlatma
USP Aralığı & Ambalaj:	USP 5/0 (metric 1) - USP 2 (metric 5) aralığında; sütürü neme karşı koruyan alüminyum folyo poşetlerde 12'lik (düzenelik) kutularda piyasaya arz edilir.



iğne bilgileri	renk	iplik boyu	1	1.5	2	3
			5/0	4/0	3/0	2/0
13 mm						
3/8 PL	renksiz	45 cm	H239			
16 mm						
1/2 yuvarlak	renksiz	75 cm	H2160	H3160	H4160	
3/8 keskin	renksiz	75 cm	H2165	H3165	H4165	
3/8 PL	renksiz	75 cm	H2169	H3169		
18 mm						
1/2 yuvarlak	renksiz	75 cm		H3180	H4180	
19 mm						
3/8 PL	renksiz	45 cm		H3199	H4199	
20 mm						
1/2 yuvarlak	renksiz	75 cm		H3200	H4200	
3/8 keskin	renksiz	75 cm		H3213	H4213	

iğne bilgileri	renk	iplik boyu	1.5	2	3	3.5	4
			4/0	3/0	2/0	0	1



25 mm							
1/2 yuvarlak		renksiz	75 cm	H3250	H4250	H5250	
3/8 keskin		renksiz	45 cm		H4255	H5255	
3/8 PL		renksiz	45 cm	H3259	H4259		

26 mm							
3/8 keskin		renksiz	75 cm		H4263	H5263	

30 mm								
1/2 yuvarlak		renksiz	75 cm		H4300	H5300	H6300	H7300

35 mm								
1/2 yuvarlak		renksiz	75 cm			H5350	H6350	H7350
			90 cm				H6360	
3/8 keskin		renksiz	75 cm		H4353	H5353		
1/2 diamond		renksiz	90 cm			H5356	H6356	

iğne bilgileri	renk	iplik boyu	3	3.5	4	5
			2/0	0	1	2

40 mm							
1/2 yuvarlak		renksiz	75 cm	H5400	H6400	H7400	H8400
		renksiz	90 cm	H5410	H6410	H7410	
1/2 diamond		renksiz	90 cm		H6406	H7406	

45 mm							
1/2 yuvarlak		renksiz	75 cm			H7450	H8450

50 mm							
1/2 yuvarlak		renksiz	90 cm	H5500	H6500	H7500	H8500

	renk	1.5	2	3	3.5	4	5
		4/0	3/0	2/0	0	1	2

iğnesiz							
150 cm	renksiz	H35	H45	H55	H65	H75	H85



tekmon®

USP 5/0_{metric 1} REF U2165
tekmon®

surgical suture/cerrahi iplik
monofilament, absorbable (emilebilir)
poly(glycolide-co-caprolactone) (PGCL)
EP, USP

undyed/bej
75 cm

16 mm 3/8
keskin/cutting



CE₀₄₇₃

LOT 12345

2011-10

2016-10

STERILEEO

dogsan

Form No: F-0853 Rev. No:0



Ürün Tanımı:	Kısa - orta dönem doku desteği sağlayan monofilament emilebilir sentetik cerrahi sütürdür. Pürüzsüz yüzeyi ve kayganlığı ile hızlı iyileşen yaralar için kullanımı uygundur.
Özellikleri:	Yüksek başlangıç mukavemeti Dokulardan yumuşak ve kolay geçiş / monofilament yumuşaklığı Minimum doku reaksiyonu Yüksek düğüm güvenliği Kısa-orta dönem doku desteği (21 gün)
Mukavemet:	~ %60 1 hafta sonra ~ %30 2 hafta sonra ~ % 0 4 hafta sonra
Emilim Profili:	Tamamen emilim süresi yaklaşık 90-120 gün
Polimer Yapısı:	polyglycolide(%75)-co-caprolactone (%25), PGCL
Filament Yapısı:	Monofilament
Renk :	Mor/Renksiz (beyaz)
Sterilizasyon Yöntemi:	EO (Etilen Oksit)
USP Aralığı & Ambalaj:	USP 6/0 (metric 0,7) - USP 2(metric 5) aralığında; sütürü neme karşı koruyan alüminyum folyo poşetlerde 12'lik (düzinelik) kutularda piyasaya arz edilir.

iğne bilgileri	iğne çapı	renk	iplik boyu	0.7	1	1.5	2
				6/0	5/0	4/0	3/0

8 mm

1/4 spatül, çift		330µ	renksiz	45 cm	U1882	U2882		
------------------	---	------	---------	-------	-------	-------	--	--

10 mm

3/8 keskin		330µ	renksiz	45 cm	U103			
------------	---	------	---------	-------	------	--	--	--

13 mm

3/8 PL		330µ	renksiz	45 cm	U139	U239		
3/8 yuvarlak		330µ	renksiz	60 cm		U231		

16 mm



1/2 yuvarlak			renksiz	75 cm		U2160		
			mor	75 cm			T3160	T4160
3/8 keskin			renksiz	75 cm		U2165	U3165	U4165
			mor	90 cm			T3175	
3/8 PL			renksiz	45 cm		U2169	U3169	

19 mm

3/8 PL			renksiz	45 cm		U2199	U3199	U4199
--------	---	--	---------	-------	--	-------	-------	-------

iğne bilgileri	renk	iplik boyu	1.5	2	3	3.5	4
			4/0	3/0	2/0	0	1



20 mm							
1/2 yuvarlak		mor	75 cm	T3200	T4200		
3/8 keskin		renksiz	75 cm	U3213	U4213		
		mor	75 cm	T3213	T4213		



25 mm							
1/2 yuvarlak		mor	75 cm	T3250	T4250	T5250	
		renksiz	75 cm		U4250	U5250	
3/8 keskin		mor	45 cm		T4255	T5255	
3/8 PL		renksiz	45 cm	U3259	U4259		

26 mm							
3/8 keskin		renksiz	75 cm		U4263	U5263	

30 mm							
1/2 yuvarlak		mor	75 cm		T4300	T5300	T6300 T7300
3/8 keskin		mor	75 cm			T5303	T6303

iğne bilgileri	renk	iplik boyu	3	3.5	4	5
			2/0	0	1	2

35 mm						
1/2 yuvarlak		mor	75 cm	T5350	T6350	T7350
3/8 keskin		mor	75 cm	T5353		

40 mm							
1/2 yuvarlak		mor	75 cm	T5400	T6400	T7400	T8400
		mor	90 cm		T6410	T7410	
1/2 keskin		mor	75 cm			T7404	T8404

45 mm						
1/2 yuvarlak		mor	75 cm			T7450

50 mm							
1/2 yuvarlak		mor	75 cm	T5500		T7500	T8500
		mor	90 cm			T7510	

63 mm						
3/8 küt karaciğer iğnesi	 blunt point	mor	75 cm			T7638

	renk	2	3	3.5	4	5
		3/0	2/0	0	1	2

iğnesiz						
150 cm	mor	T45	T55	T65	T75	T85



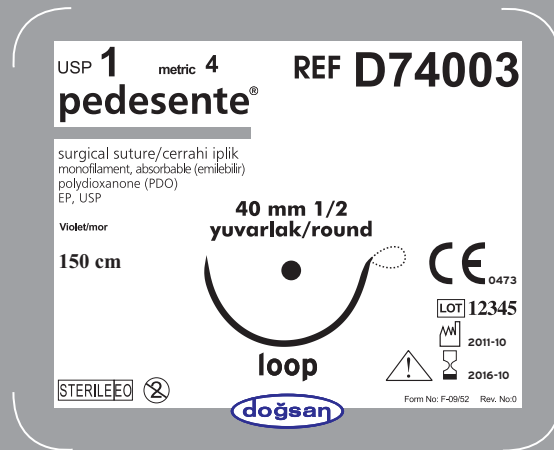

pedesente®









Ürün Tanımı:	Uzun dönem doku desteği sağlayan monofilament sentetik emilebilir cerrahi sütürdür. Yavaş iyileşen dokular için idealdir.
Özellikleri:	Dokulardan yumuşak ve kolay geçiş / monofilament yumuşaklığı Yüksek başlangıç mukavemeti Yavaş mukavemet kaybı Minimum doku reaksiyonu Uzun dönem doku desteği için ideal Uzun dönem doku desteği (~ 60 gün)
Mukavemet:	~ %75 2 hafta sonra ~ %60 4 hafta sonra ~ %0 10 hafta sonra
Emilim Profili:	Tamamen emilim süresi yaklaşık 180-210 gün
Polimer Yapısı:	polydioxanone,PDO 100%
Filament Yapısı:	Monofilament
Renk :	Mor
Sterilizasyon Yöntemi:	EO (Etilen oksit)
USP Aralığı & Ambalaj:	USP 7/0 (metric 0,5) - USP 2 (metric 5) aralığında; sütürü neme karşı koruyan alüminyum folyo poşetlerde 12'lik (düzinelik) kutularda piyasaya arz edilir.





iğne bilgileri	iğne çapı	renk	iplik boyu	0.5	0.7	1	1.5	2
				7/0	6/0	5/0	4/0	3/0









8 mm									
3/8 yuvarlak, çift		220 µ	mor	75 cm	D0812				
		330 µ	mor	45 cm		D1812			
				75 cm		D1912			
3/8 KD, çift		330 µ	mor	60 cm		D1872			
3/8 yuvarlak		330 µ	mor	30 cm		D181			

9 mm									
3/8 yuvarlak, çift		200 µ	mor	75 cm	D0912				

10 mm									
3/8 keskin		330 µ	mor	45 cm		D103			
3/8 keskin, çift		330 µ	mor	45 cm		D1032			

13 mm									
3/8 yuvarlak, çift		220 µ	mor	45 cm	D0312				
		330 µ	mor	75 cm		D1312	D2312		
3/8 PL		380 µ	mor	45 cm		D139	D239		

16 mm									
1/2 yuvarlak			mor	75 cm			D2160	D3160	D4160
3/8 yuvarlak			mor	75 cm			D2161	D3161	
1/2 yuvarlak, çift			mor	90 cm			D21602	D31602	
3/8 keskin			mor	75 cm			D2165	D3165	D4165
3/8 PL			mor	45 cm			D2169	D3169	

iğne bilgileri	renk	iplik boyu	1	1.5	2	3	3.5	
			5/0	4/0	3/0	2/0	0	
19 mm								
3/8 PL		mor	45 cm	D2199	D3199	D4199		
20 mm								
1/2 yuvarlak		mor	75 cm		D3200	D4200		
3/8 keskin		mor	45 cm		D3203	D4203		
25 mm								
1/2 yuvarlak		mor	75 cm		D3250	D4250	D5250	D6250
3/8 keskin		mor	45 cm		D3255	D4255	D5255	
3/8 PL		mor	45 cm		D3259	D4259		
26 mm								
3/8 keskin		mor	75 cm			D4263		
30 mm								
1/2 yuvarlak		mor	75 cm			D4300	D5300	D6300
3/8 keskin		mor	75 cm				D5303	

iğne bilgileri	renk	iplik boyu	3	3.5	4	5
			2/0	0	1	2

40 mm							
1/2 yuvarlak		mor	75 cm	D5400	D6400	D7400	D8400
		mor	90 cm			D7410	D8410
1/2 yuvarlak, loop		mor	150 cm		D64003	D74003	

45 mm							
1/2 yuvarlak		mor	75 cm			D7450	D8450

50 mm							
1/2 yuvarlak		mor	75 cm		D6500	D7500	D8500
		mor	90 cm				D8510
1/2 yuvarlak, loop		mor	150 cm		D65003	D75003	

propilen®
polypropylene

trofilen®
polyvinylidene fluoride

daylon®
polyamide

politer®
polyester

ipek
ipek

tektel®
paslanmaz çelik tel

Emilmeyen Sütürlerimiz



propilen®

USP 7/0^{metric} 0.5 REF P0814
propilen®

surgical suture/cerrahi iplik
monofilament, non-absorbable,
polypropylene
EP, USP

mavi/blue

60 cm

8 mm 3/8
yuvarlak-round
siyah-black



çift-double
220 µ

CE⁰⁴⁷³

LOT 12345

2011-10

2016-10

TSEK
STERILE



Form No: F-0935 Rev. No:2



Ürün Tanımı:	Yoğun polypropylene polimerinin ekstrüde edilmesinden elde edilen monofilament, emilmeyen cerrahi sütürdür. Çok düzgün bir yüzeye sahiptir. Kardiyovasküler cerrahi için idealdir.
Özellikleri:	Kardiyovasküler cerrahide ideal sütür Dokulardan kaygan ve yumuşak geçiş Çok yüksek mukavemet Yüksek kayganlık ve esneklik Minimum doku reaksiyonu, enfekte dokularda ideal sütür Yüksek düğüm güvenliği
Mukavemet:	Kalıcı - çok yüksek mukavemet
Polimer Yapısı:	polypropylene
Filament Yapısı:	Monofilament
Renk:	Mavi/Renksiz (beyaz)
Sterilizasyon Yöntemi:	EO (Etilen Oksit)
USP Aralığı & Ambalaj:	USP 10/0 (metric 0.2) - USP 2 (metric 5) aralığında 12'lik (düzinelik) kutularda piyasaya arz edilir.

iğne bilgileri	iğne çapı	iplik boyu	0.2	0.3	0.4	0.5	0.7	1
			10/0	9/0	8/0	7/0	6/0	5/0



5 mm

3/8 yuvarlak		100 µ	13 cm	M2205	M3205				
--------------	---	-------	-------	-------	-------	--	--	--	--

6 mm





3/8 yuvarlak, çift		160 µ	60 cm			P9612			
--------------------	---	-------	-------	--	--	-------	--	--	--

8 mm







3/8 yuvarlak, çift		160 µ	60 cm			P9812				
		220 µ	60 cm				P0812	P1812		
		180 µ	60 cm				P0822			
	 siyah	160 µ	60 cm			P9814				
		220 µ	60 cm				P0814	P1814		
	3/8 KD, çift		180 µ	60 cm			P9872			
220 µ			60 cm				P0872	P1872		

9 mm







3/8 yuvarlak, çift		200 µ	75 cm				P0912		
		 siyah	200 µ	60 cm				P0914	



iğne bilgileri	iğne çapı	iplik boyu	0.4	0.5	0.7	1	
			8/0	7/0	6/0	5/0	
10 mm							
3/8 yuvarlak, çift		220 µ	60 cm		P0012		
		240 µ	60 cm			P1012	
			75 cm			P1112	
		330 µ	60 cm				P2012
		330 µ	75 cm				P2112
siyah		220 µ	60 cm		P0014	P1014	
			75 cm			P1114	
1/2 yuvarlak, çift		220 µ	75 cm			P1002	
3/8 KD, çift		200 µ	60 cm		P0072		
		200 µ	60 cm		P0074		
			220 µ	60 cm			P1074
3/8 keskin		280 µ	45 cm			P103	

iğne bilgileri	iğne çapı	iplik boyu	0.5	0.7	1	1.5
			7/0	6/0	5/0	4/0

13 mm							
3/8 yuvarlak		280 μ	60 cm		P131		
			75 cm		P141		
		330 μ	60 cm			P231	
3/8 yuvarlak, çift		220 μ	60 cm	P0312			
		280 μ	60 cm		P1312		
		220 μ	75 cm	P0412			
		280 μ	75 cm		P1412		
		330 μ	75 cm			P2312	
			90 cm			P2412	
		380 μ	75 cm				P3312
siyah		240 μ	60 cm	P0314			
			60 cm		P1314		
			75 cm		P1414		
1/2 yuvarlak, çift		220 μ	75 cm		P1302		
		330 μ	75 cm			P2302	
3/8 KD, çift		280 μ	75 cm		P1372		
		330 μ	75 cm			P2372	
3/8 keskin		280 μ	45 cm		P133		
		380 μ	45 cm			P233	P333

iğne bilgileri	renk	iplik boyu	0.7	1	1.5	2
			6/0	5/0	4/0	3/0

16 mm							
1/2 yuvarlak		mavi	60 cm	P1160			
		mavi	75 cm		P2160	P3160	P4160
1/2 yuvarlak, çift		mavi	90 cm		P21602	P31602	P41602
		mavi	90 cm		P21604	P31604	
1/2 KD, çift		mavi	90 cm		P21672	P31672	P41672
3/8 yuvarlak, çift		mavi	90 cm		P21612	P31612	
3/8 keskin		mavi	45 cm	P1165	P2165	P3165	
		mavi	75 cm				P4165
3/8 keskin		mavi	45 cm	P1163	P2163	P3163	
		mavi	75 cm				P4163
		mavi	75 cm		P2173	P3173	
3/8 PL		mavi	45 cm	P1169		P3169	

18 mm							
1/2 yuvarlak		mavi	75 cm			P3180	P4180
		renksiz	75 cm			X3180	
3/8 keskin		mavi	75 cm		P2183	P3183	
		renksiz	75 cm			X3183	

19 mm							
3/8 PL		mavi	45 cm		P2199	P3199	P4199

iğne bilgileri	renk	iplik boyu	1	1.5	2	3	3.5
			5/0	4/0	3/0	2/0	0





20 mm								
1/2 yuvarlak		mavi	75 cm	P2200	P3200	P4200	P5200	
1/2 yuvarlak, çift		mavi	90 cm	P22002	P32002	P42002		
		mavi	90 cm		P32004			
1/2 KD, çift		mavi	90 cm	P22072	P32072			
3/8 keskin		mavi	45 cm	P2205	P3205	P4205		
3/8 keskin		mavi	45 cm	P2203	P3203	P4203		
		mavi	75 cm	P2213	P3213	P4213		



22 mm								
1/2 yuvarlak, çift		mavi	90 cm	P22202	P32202			
1/2 keskin		mavi	45 cm			P4224		

25 mm								
1/2 yuvarlak		mavi	75 cm		P3250	P4250	P5250	P6250
		renksiz	75 cm			X4250		
1/2 yuvarlak, çift		mavi	90 cm		P32502	P42502	P52502	
		mavi	90 cm		P32504	P42504		
3/8 PL		mavi	45 cm	P2259	P3259	P4259		
1/2 KD, çift		mavi	90 cm		P32572	P42572	P52572	
3/8 keskin		mavi	45 cm		P3255	P4255	P5255	
		mavi	75 cm		P3245			



iğne bilgileri	renk	iplik boyu	2	3	3.5	4
			3/0	2/0	0	1



26 mm							
3/8 keskin		mavi	75 cm	P4263	P5263		
		renksiz	75 cm	X4263			



30 mm							
1/2 yuvarlak		mavi	75 cm	P4300	P5300	P6300	
		mavi	100 cm				P7300
1/2 yuvarlak, çift		mavi	90 cm	P43002	P53002		
1/2 keskin		mavi	75 cm		P5304		
3/8 keskin		mavi	75 cm	P4303	P5303	P6303	

35 mm							
1/2 yuvarlak		mavi	75 cm		P5350		
		mavi	100 cm			P6350	P7350
3/8 keskin		mavi	75 cm	P4353	P5353		

iğne bilgileri	iplik boyu	3	3.5	4	5
		2/0	0	1	2

40 mm						
1/2 yuvarlak		100 cm	P5400	P6400	P7400	P8400
1/2 keskin		100 cm		P6404	P7404	
3/8 keskin		100 cm	P5403		P7403	

45 mm						
1/2 yuvarlak	 loop	150 cm			P74503	
1/2 diamond		100 cm			P7456	

50 mm						
1/2 yuvarlak		100 cm			P7500	
	 loop	150 cm		P65003	P75003	
		200 cm			P75103	
1/2 keskin		100 cm			P7504	

iğne bilgileri	iplik boyu	2	3	3.5	4
		3/0	2/0	0	1

60 mm					
düz keskin		75 cm	P4608	P5608	

90 mm					
3/8 keskin, retansiyon suturü		2x50 cm			P79056



trofilen®

USP **5/0**_{metric 1} REF **F2163**
trofilen®

surgical suture/cerrahi iplik
monofilament, non-absorbable,
polyvinylidene fluoride
EP, USP

mavi/blue

45 cm

**16 mm 3/8
keskin-cutting**



CE 0473

LOT 12345

MM 2011-10

2016-10



TSEK
STERILEEO





doğan

Form No: F-0936 Rev: No:2



Ürün Tanımı:	Polyvinylidene fluoride (PVDF) polimerinden özel ekstrüde edilen monofilament emilmeyen cerrahi sütürdür. Tamamen inert bir yapıya sahip olan bu sütür plastik cerrahi ve kardiyovasküler cerrahi için idealdir.
Özellikleri:	Dokulardan kaygan ve yumuşak geçiş Monofilament sütürler içinde en güçlü mukavemet Mükemmel bükülme ve esneklik Minimum doku reaksiyonu, enfekte dokularda ideal sütür
Mukavemet:	Kalıcı - çok yüksek mukavemet
Polimer Yapısı:	polyvinylidene fluoride (PVDF)
Filament Yapısı:	Monofilament
Renk :	Mavi
Sterilizasyon Yöntemi:	EO (Etilen Oksit)
USP Aralığı & Ambalaj:	USP 8/0 (metric 0.4) - USP 2 (metric 5) aralığında 12'lik (düzinelik) kutularda piyasaya arz edilir.



iğne bilgileri	iğne çapı	iplik boyu	0.4	0.5	0.7	1
			8/0	7/0	6/0	5/0
8 mm						
3/8 yuvarlak, çift		160 μ	60 cm	F9812		
		220 μ	60 cm		F0812	F1812
	 siyah	160 μ	60 cm	F9814		
		220 μ	75 cm		F0814	
		220 μ	60 cm			F1814
	3/8 KD, çift		180 μ	60 cm	F9872	
220 μ			60 cm		F0872	F1872
3/8 keskin		220 μ	45 cm		F083	

10 mm						
3/8 yuvarlak, çift		220 μ	60 cm		F0012	
		240 μ	60 cm			F1012
	 siyah	220 μ	60 cm		F0014	
3/8 KD, çift		220 μ	60 cm		F0072	
		330 μ	60 cm			F2072
	 siyah	200 μ	60 cm		F0074	
3/8 keskin		280 μ	45 cm			F103

iğne bilgileri	iğne çapı	iplik boyu	0.5	0.7	1	1.5
			7/0	6/0	5/0	4/0
13 mm						
3/8 yuvarlak		280 μ	60 cm		F131	
		330 μ	60 cm			F231
3/8 yuvarlak, çift		220 μ	60 cm	F0312		
		280 μ	60 cm		F1312	
			75 cm		F1412	
		330 μ	75 cm			F2312
	 siyah	220 μ	60 cm	F0314		
		240 μ	60 cm		F1314	
		240 μ	75 cm		F1414	
		330 μ	75 cm			F2314
1/2 yuvarlak, çift		330 μ	75 cm			F2302
3/8 keskin		280 μ	45 cm		F133	
		380 μ	45 cm			F233

iğne bilgileri	iplik boyu	0.7	1	1.5	2
		6/0	5/0	4/0	3/0

16 mm







1/2 yuvarlak		60 cm	F1160			
		75 cm		F2160	F3160	F4160
1/2 yuvarlak, çift		90 cm		F21602	F31602	F41602
		90 cm		F21604	F31604	
1/2 KD, çift		90 cm		F21672	F31672	F41672
3/8 keskin		45 cm	F1165	F2165	F3165	
		75 cm				F4165
3/8 keskin		45 cm	F1163	F2163	F3163	
		75 cm				F4163
3/8 PL		45 cm	F1169	F2169	F3169	

19 mm







3/8 PL		45 cm		F2199	F3199	F4199
--------	---	-------	--	-------	-------	-------

iğne bilgileri	iplik boyu	1	1.5	2	3	3.5
		5/0	4/0	3/0	2/0	0

20 mm

1/2 yuvarlak		75 cm	F2200	F3200	F4200	F5200
1/2 yuvarlak, çift		90 cm	F22002	F32002	F42002	
	 siyah	90 cm		F32004		
1/2 KD, çift		90 cm	F22072	F32072		
3/8 keskin		45 cm	F2205	F3205	F4205	
3/8 keskin		45 cm	F2203	F3203	F4203	



25 mm



1/2 yuvarlak		75 cm		F3250	F4250	F5250
1/2 yuvarlak, çift		90 cm		F32502	F42502	F52502
	 siyah	90 cm		F32504	F42504	
3/8 PL		45 cm	F2259	F3259	F4259	
1/2 KD, çift		90 cm		F32572	F42572	F52572
3/8 keskin		45 cm		F3255	F4255	F5255

26 mm



3/8 keskin		75 cm			F4263	F5263
------------	---	-------	--	--	-------	-------

iğne bilgileri	iplik boyu	2	3	3.5	4	5
		3/0	2/0	0	1	2

30 mm						
1/2 yuvarlak		75 cm	F4300	F5300	F6300	
		100 cm				F7300
1/2 keskin		75 cm		F5304		
3/8 keskin		75 cm	F4303	F5303	F6303	



35 mm						
1/2 yuvarlak		75 cm		F5350		
		100 cm			F6350	F7350
3/8 keskin		75 cm	F4353	F5353		
3/8 keskin		75 cm				F7355

36 mm						
5/8 yuvarlak		75 cm				F7368

40 mm						
1/2 yuvarlak		100 cm		F5400	F6400	F7400
1/2 keskin		100 cm			F6404	F7404
3/8 keskin		100 cm		F5403		F7403

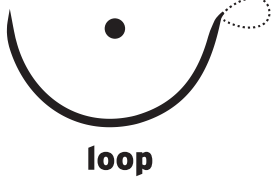
iğne bilgileri	iplik boyu	2	3	3.5	4	5
		3/0	2/0	0	1	2

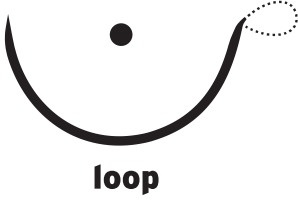
45 mm						
1/2 yuvarlak		150 cm		F64503	F74503	

50 mm						
1/2 yuvarlak		100 cm			F7500	F8500
		150 cm		F65003	F75003	
1/2 keskin		100 cm			F7504	

60 mm						
düz keskin		75 cm	F4608	F5608		

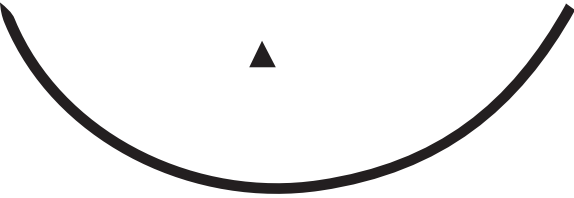
90 mm						
3/8 keskin retansiyon sütür		2x50 cm			F79056	



daylon®

USP **6/0**_{metric 0.7} REF **Y139**
daylon®



surgical suture/cerrahi iplik
 monofilament, non-absorbable,
 polyamide 66
 EP, USP

mavi/blue

13 mm 3/8
PL

45

TS 5504
STERILEEO 

₀₄₇₃
 LOT 12345
 2011-05
 2016-05

Form No: F-09/08 Rev: No:1



Ürün Tanımı:	Poliamidden elde edilen monofilament, emilmeyen cerrahi sütürdür. Plastik cerrahi ve göz cerrahisi için çok kullanılan, tercih edilen klasik bir sütürdür.
Özellikleri:	Uniform kalınlık (çap) Minimum iplik hafızası Yüksek esneklik Yüksek düğüm güvenliği Dokulardan kaygan ve yumuşak geçiş
Mukavemet:	Kalıcı
Polimer Yapısı:	polyamide
Filament Yapısı:	Monofilament
Renk:	Mavi : USP 6/0 - USP 2 Siyah: USP 12/0 - USP 8/0
Sterilizasyon yöntemi:	EO (Etilen Oksit)
USP aralığı & Ambalaj:	USP 12/0 (metric 0.01) - USP 2 (metric 5) aralığında 12'lik (düzinelik) kutularda piyasaya arz edilir.

iğne bilgileri	iğne çapı	renk	iplik boyu	0.01	0.1	0.2	0.3	0.4
				12/0	11/0	10/0	9/0	8/0

4 mm									
3/8 yuvarlak		50 μ	siyah	13 cm	M0102				
		70 μ	siyah	13 cm		M1102			
		100 μ	siyah	13 cm			M2102	M3102	
		140 μ	siyah	13 cm					M4112

5 mm									
3/8 yuvarlak		100 μ	siyah	13 cm			M2105	M3105	
		140 μ	siyah	13 cm					M4115



6 mm									
3/8 spatül, çift		150 μ	siyah	30 cm			M2177	M3167	
		200 μ	siyah	45 cm			M2187		
3/8 yuvarlak		140 μ	siyah	13 cm					M4117

iğne bilgileri	iğne çapı	renk	iplik boyu	0.7	1	1.5	2
				6/0	5/0	4/0	3/0



10 mm

3/8 keskin		280µ	mavi	45 cm	Y103			
------------	---	------	------	-------	------	--	--	--

13 mm

3/8 keskin		280µ	mavi	45 cm	Y133			
3/8 PL		330µ	mavi	45 cm	Y139	Y239		

16 mm

3/8 keskin		mavi	45 cm	Y1163	Y2163	Y3163	
		mavi	75 cm				Y4163
		renksiz	75 cm				V4163
3/8 PL		mavi	45 cm	Y1169	Y2169	Y3169	

19 mm

3/8 PL		mavi	45cm		Y2199	Y3199	Y4199
		renksiz	45cm				V4199

20 mm

3/8 keskin		mavi	45cm		Y2203	Y3203	Y4203
3/8 keskin		mavi	45cm			Y3205	Y4205

iğne bilgileri	renk	iplik boyu	1	1.5	2	3	3.5	4
			5/0	4/0	3/0	2/0	0	1

25 mm

3/8 keskin		mavi	45 cm		Y3255	Y4255			
3/8 PL		mavi	45 cm	Y2259	Y3259	Y4259			

26 mm

3/8 keskin		mavi	75 cm			Y4263	Y5263		
		renksiz	75 cm			V4263	V5263		



30 mm

1/2 yuvarlak		mavi	100 cm					Y6300	Y7300
3/8 keskin		mavi	75 cm			Y4303	Y5303		
		renksiz	75 cm				V5303		

35 mm

1/2 yuvarlak		mavi	100 cm					Y6350	Y7350
--------------	---	------	--------	--	--	--	--	-------	-------

40 mm

1/2 yuvarlak		mavi	100 cm				Y5400	Y6400	Y7400
1/2 keskin		mavi	100 cm					Y6404	Y7404
3/8 keskin		mavi	100 cm						Y7403

iğne bilgileri	renk	iplik boyu	2	3	3.5	4
			3/0	2/0	0	1

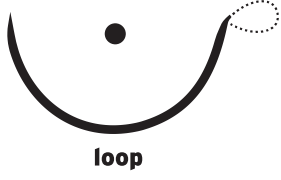
45 mm						
1/2 yuvarlak		mavi	150 cm			Y64503 Y74503

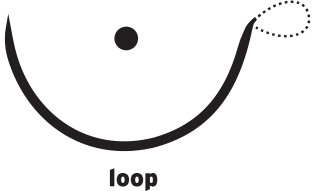
50 mm						
1/2 yuvarlak		mavi	150 cm			Y65003 Y75003

60 mm						
düz keskin		mavi	75 cm	Y4608	Y5608	



politer®

USP **2/0**_{metric 3} REF **R52502**
politer®

surgical suture/cerrahi iplik
braided/örgülü, non-absorbable,
non-capillary polyester, coated
EP, USP

yesil/green

90 cm

25 mm 1/2
yuvarlak-round



çift-double

CE 0473

LOT 12345

2011-10

2016-10











TS 5503
STERILEEQ

doğsan

Form No: F-09/07 Rev. No:1



Ürün Tanımı:	Polyester filamentlerinin örülmesinden elde edilen örgülü, kaplanmış, sentetik emilmeyen cerrahi sütürdür. Kardiyovasküler ve implant cerrahilerinde uzun dönem destek sağlayan ideal sütürdür.
Özellikleri:	Mükemmel mukavemet Kalıcı doku desteği Mükemmel düğüm güvenliği Mükemmel kullanım kolaylığı Gergin durumda maximum güvenlik
Mukavemet:	kalıcı - in vivo çalışmalarda mukavemet belirgin seviyede azalma göstermemektedir.
Polimer Yapısı:	polyethylene terephthalate (polyester)
Kaplama:	Silikon bazlı
Filament Yapısı:	Örgülü (multifilament)
Renk:	Yeşil/ beyaz
Sterilizasyon Yöntemi:	EO (Etilen Oksit)
USP Aralığı & Ambalaj:	USP 5/0 (metric 1) - USP 5 (metric 7) aralığında 12'lik (düzinelik) kutularda piyasaya arz edilir.
Aksesuar:	PTFE Pledget'li kalp kapağı sütürleri mevcuttur.

iğne bilgileri	iğne çapı	renk	iplik boyu	1	1.5	2	3	
				5/0	4/0	3/0	2/0	
8 mm								
1/4 spatül, çift		330 μ	beyaz	45 cm	02882			
		330 μ	yeşil	45 cm	R2882			
13 mm								
3/8 keskin		380 μ	yeşil	45 cm	R233	R333		
16 mm								
1/2 yuvarlak			yeşil	75 cm		R3160	R4160	
1/2 yuvarlak, çift			yeşil	90 cm		R31602	R41602	
3/8 keskin			yeşil	75 cm		R3165	R4165	
17 mm								
1/2 yuvarlak, çift			yeşil	90 cm		R31702	R41702	R51702
1/2 yuvarlak, çift			yeşil	75 cm			R5170P	
		 PTFE Pledget'li 6 x 3 mm	beyaz	75 cm			05170P	
1/2 diamond, çift			yeşil	90 cm	R21762	R31762	R41762	R51762
18 mm								
3/8 diamond, çift			yeşil	75 cm			R41862	
20 mm								
1/2 yuvarlak, çift			yeşil	90 cm		R32002	R42002	R52002
			yeşil	75 cm		R31902	R41902	R51902
1/2 yuvarlak, çift			yeşil	75 cm				R5190P
		 PTFE Pledget'li 6 x 3 mm	beyaz	75 cm				05190P

iğne bilgileri	renk	iplik boyu	2	3	3.5	4	5
			3/0	2/0	0	1	2



25 mm							
1/2 yuvarlak		yeşil	75 cm	R4250	R5250	R6250	
1/2 yuvarlak, çift		yeşil	75 cm	R42402	R52402		
		yeşil	90 cm	R42502	R52502	R62502	
		yeşil	75 cm		R5240P		
		beyaz	75 cm		O5240P		
1/2 diamond, çift		yeşil	90cm	R42562	R52562		
		yeşil	75cm		R5256P		
	beyaz	75cm		O5256P			
3/8 keskin		yeşil	75 cm	R4255	R5255		

30 mm							
1/2 yuvarlak		yeşil	75 cm		R5300	R6300	
3/8 keskin		yeşil	75 cm	R4303	R5303		

40 mm							
1/2 yuvarlak		yeşil	75 cm			R7400	R8400

45 mm							
1/2 diamond		yeşil	75 cm				R8456

iğne bilgileri	iplik boyu	3	3.5	4	5	7
		2/0	0	1	2	5

50 mm						
1/2 yuvarlak		75 cm			R7500	R8500
düz keskin		75 cm	R5508			

55 mm						
1/2 diamond		75 cm				R9556

	2	3	3.5	4
	3/0	2/0	0	1

iğnesiz					
17x45 cm		R41	R51	R61	R71
13x60 cm		R43	R53	R63	



ipek

USP 2/0 metric 3 REF S51
ipek/silk

surgical suture/cerrahi iplik
braided/örgülü, non-absorbable,
non-capillary silk, coated
EP, USP

siyah/black

17x45 cm

12 Adet/pouches

CE 0473

LOT 12345

TS 5505

STERILE EO

doğan

Form No: F-09/04 Rev. No:1



Ürün Tanımı:	Doğal ipek fiberlerinden (fibron) elde edilen kaplanmış örgülü (multifilament), emilmeyen cerrahi sütürdür. Rahat kullanım özelliği sayesinde tüm cerrahi branşlarda en çok tercih edilen sütürdür.
Özellikleri:	Yüksek kullanım kolaylığı Yüksek düğüm güvenliği Dokulardan kaygan ve yumuşak geçişi sağlamak için kaplanmıştır.
Mukavemet:	İpek fiberlerinin aşamalı ayrışması sonucu uzun dönem içinde mukavemetinde dereceli azalma olur.
Polimer Yapısı:	Bombyx mori doğal ipek fiberleri
Kaplama Malzemesi:	Silikon bazlı
Filament Yapısı:	Örgülü(multifilament) / Bükülmüş saf ipek (yalnızca 8/0)
Renk :	Siyah / Mavi (sadece 8/0 virjin ipek)
Sterilizasyon yöntemi:	EO (Etilen Oksit)
USP aralığı & Ambalaj:	USP 8/0 (metric 0.4) - USP 3 (metric 6) aralığında 12'lik (düzinelik) kutularda piyasaya arz edilir.



iğne bilgileri	iğne çapı	iplik boyu	0.4	0.5	0.7	
			8/0	7/0	6/0	
6 mm						
3/8 spatül, çift		140 μ	30 cm	M4367		
		200 μ	45 cm	M4387		



ipek



örgülü silikon kaplı ipek, siyah

iğne bilgileri	iğne çapı	iplik boyu	0.7	1	1.5	
			6/0	5/0	4/0	
8 mm						
1/4 spatül, çift		280 μ	45 cm	S1882		
		330 μ	45 cm		S2882	
10 mm						
3/8 yuvarlak		330 μ	75 cm		S201	
3/8 keskin		330 μ	45 cm	S103		
13 mm						
3/8 yuvarlak		330 μ	45 cm	S131		
		330 μ	75 cm		S231	
		380 μ	75 cm			S331
3/8 keskin		280 μ	45 cm	S133		
		380 μ	45 cm		S233	S333

iğne bilgileri	iplik boyu	0.7	1	1.5	2	3
		6/0	5/0	4/0	3/0	2/0

16 mm						
1/2 yuvarlak		45 cm	S1160			
		75 cm		S2160	S3160	S4160
3/8 keskin		45 cm	S1165			
		75 cm		S2165	S3165	S4165



18 mm						
1/2 yuvarlak		75 cm		S2180	S3180	S4180
3/8 keskin		75 cm		S2185	S3185	S4185



20 mm							
1/2 yuvarlak		75 cm		S2200	S3200	S4200	S5200
3/8 keskin		75 cm		S2205	S3205	S4205	
3/8 keskin		75 cm		S2203	S3203	S4203	S5203



22 mm							
1/2 keskin		75 cm			S3224	S4224	S5224



25 mm							
3/8 keskin		75 cm		S2255	S3255	S4255	S5255

iğne bilgileri	iplik boyu	1.5	2	3	3.5	4
		4/0	3/0	2/0	0	1



26 mm						
1/2 yuvarlak		75 cm	S3260	S4260	S5260	S6260
3/8 keskin		75 cm	S3263	S4263	S5263	S6263

30 mm							
1/2 yuvarlak		75 cm		S4300	S5300	S6300	S7300
3/8 keskin		75 cm		S4303	S5303	S6303	
1/2 keskin		75 cm			S5304	S6304	S7304

35 mm							
1/2 yuvarlak		75 cm			S5350	S6350	S7350
3/8 keskin		75 cm					S7355
3/8 keskin		75 cm		S4353	S5353		

37 mm							
1/2 keskin		75 cm				S6374	S7374
1/2 yuvarlak		75 cm				S6370	S7370

iğne bilgileri	iplik boyu	2	3	3.5	4	5
		3/0	2/0	0	1	2

40 mm							
1/2 yuvarlak		75 cm		S5400	S6400	S7400	S8400
3/8 keskin		75 cm			S6403	S7403	
1/2 keskin		75 cm				S7404	

50 mm							
düz keskin		75 cm	S4508	S5508			

60 mm							
düz keskin		75 cm	S4608	S5608			

	1.5	2	3	3.5	4	5	6
	4/0	3/0	2/0	0	1	2	3

iğnesiz							
17x45 cm	S31	S41	S51	S61	S71	S81	
13x60 cm	S33	S43	S53	S63	S73		
180 cm		S42	S52	S62	S72	S82	S92
10x75 cm		S46	S56	S66	S76	S86	



tektel®

USP **7** metric **9**

REF **E1487**

tektel®

surgical suture/cerrahi iplik
nonabsorbable/emilmeyen
stainless steel wire/cerrahi çelik tel
monofilament

4x45 cm

48 mm 1/2
diamond fixed head needle
sabit iğne

12 Adet/pouches



CE 0473

LOT 12345

2011-10

2016-10

STERILE



doğsan



Form No: F-09/40 Rev. No:1





Ürün Tanımı:	Cerrahi paslanmaz çelik tel sûtür, ISO 5832-1 "Cerrahi İmplantlar için metalik malzemeler" standardına uygun paslanmaz çelik tel, emilmeyen steril sûtürdür.
Özellikleri:	Sternotomi için ideal sûtürdür. Düzgün yüzey ve yumuşak yapı dokulardan kolay geçiş sağlar. Çok yüksek mukavemet ve minimum doku reaksiyonuna sahiptir.
Mukavemet:	Dokuda kalıcı gerilim gücünün korunmasını sağlar.
Filament Yapısı:	Monofilament
Metal Yapısı:	316L
Renk :	Metalik gri
Sterilizasyon yöntemi:	EO (Etilen Oksit)
USP aralığı & Ambalaj:	USP 2 (metrik 5) - USP 8 (metrik 10) aralığında döner veya sabit iğneli 12'lik (düzinelik)* kutularda piyasaya arz edilir.

*Her poşette 2'li (75 cm'lik) veya 4'lü (45cm ve 75 cm'lik) paketlerde

iğne bilgileri	iplik boyu	5	6	7	8	9
		2	3&4	5	6	7

45 mm							
1/2 taper-cut	 Sabit iğneli	4 x 45 cm	E7457	E8457			
		2 x 45 cm	E7459				

48 mm							
1/2 taper-cut	 Döner iğneli	4 x 45 cm			E9486	E0486	E1486
		2 x 75 cm			E9488	E0488	E1488
	 Sabit iğneli	4 x 45 cm			E9487	E0487	E1487

55 mm							
1/2 keskin	 Döner iğneli	2 x 75 cm			E9553	E0553	
		4 x 45 cm			E9551	E0551	E1551



Mikrocerrahi & Oftalmoloji

Mikrocerrahi

iğne bilgileri	iğne çapı	iplik boyu	0.01	0.1	0.2	0.3	0.4
			12/0	11/0	10/0	9/0	8/0

4 mm										
3/8 yuvarlak (kiriş = 3.14 mm)		daylon siyah	50 µ	13 cm	M0102					
		daylon siyah	70 µ	13 cm		M1102				
		daylon siyah	100 µ	13 cm			M2102	M3102		
		daylon siyah	140 µ	13 cm						M4112

5 mm										
3/8 yuvarlak (kiriş = 3.92 mm)		daylon siyah	100 µ	13 cm			M2105	M3105		
		propilen mavi	100 µ	13 cm			M2205	M3205		
		daylon siyah	140 µ	13 cm						M4115

6 mm									
3/8 yuvarlak (kiriş = 4.71 mm)		daylon siyah	140 µ	13 cm			M2117	M3117	M4117
3/8 yuvarlak, çift (kiriş = 4.71 mm)		propilen mavi	160 µ	60 cm					P9612

8 mm									
3/8 yuvarlak, çift (kiriş = 6.27 mm)		propilen mavi	160 µ	60 cm					P9812
	 siyah	propilen mavi	160 µ	60 cm					P9814

Oftalmoloji

iğne bilgileri	iğne çapı	iplik boyu	0.2	0.3	0.4
			10/0	9/0	8/0

6 mm							
3/8 spatül, çift (kiriş = 4.71 mm)		daylon siyah	150 µ	30 cm	M2177	M3167	
		v. ipek mavi	140 µ	30 cm			M4367
		daylon siyah	200 µ	45 cm	M2187		
		v. ipek mavi	200 µ	45 cm			M4387



Cerrahi Dikiş Malzemeleri

IGK/2011

Doğsan Tıbbi Malzeme Sanayi A.Ş.
Yıldız Cad. No: 55/1 Beşiktaş 34353
İSTANBUL/TÜRKİYE

Tel: +90 (212) 258 00 54
Faks: +90 (212) 227 47 74

www.dogsan.com.tr
e-mail: dogsan@dogsan.com.tr